

Data Sheet

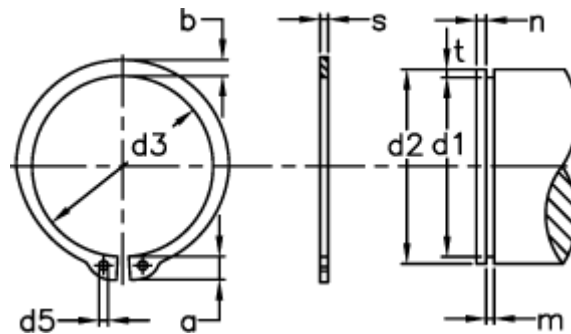

Article number: 0109069
 Description: Retaining ring AS 52x3.0
 Spring steel
 Note: Fitted with ZGA pliers

Measures



a max	= 8.2	Description	= AS 52	s	= 3.00
AN mm ²	= 238.0	FN kN	= 39.70	t	= 1.50
B	= 2.25	FRg kN	= 26.0	tol	= -0.25
b	= 5.2	FR kN	= 165.0	tol	= -0.08
d1	= 49.0	g	= 2.5	tol	= +0,39 -0,90
d2	= 52	m min	= 3.15	Tong	= ZGA-3
d3	= 47.8	n abl x 1000	= 10	Weight kg/1000	= 15.40
d5 min	= 2.5	Nominal drive	= 4.5		